

➤ General Description

This PAP84TB73QB P-Channel enhancement mode power field effect transistor is the high density trench technology and this advanced technology can provide excellent $R_{ds(On)}$ performance and efficiency for power switching and load switching application., this device also comply with the RoHS and Green Product requirement with full function reliability approved.

➤ Feature

- Green Device Available
- Super Low Gate Charge
- Excellent CdV/dt effect decline
- Advanced high cell density Trench technology
- SOT-223 package design

➤ SOT-223

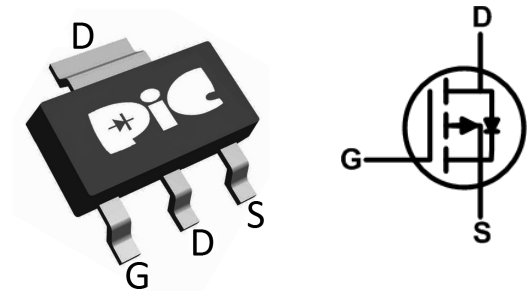

➤ Application

- Motor and Load Control
- Power Management in White LED System
- Push Pull Converter
- LCD TV Inverter & AD/DC Inverter Systems.

➤ Absolute Maximum Ratings

Parameter	Symbol	Rating	Unit
Drain-Source Voltage	V_{DSS}	-60	V
Gate –Source Voltage	V_{GSS}	± 20	V
Continuous Drain Current($T_J=150^\circ C$)	I_D	$T_A=25^\circ C$	-4.8
		$T_A=70^\circ C$	-3.6
Pulsed Drain Current	I_{DM}	-10	A
Continuous Source Current(Diode Conduction)	I_S	-1.6	A
Power Dissipation	P_D	$T_A=25^\circ C$	2.8
		$T_A=70^\circ C$	1.2
Operating Junction Temperature	T_J	150	$^\circ C$
Storage Temperature Range	T_{STG}	-55/150	$^\circ C$
Thermal Resistance-Junction to Ambient	$R_{\theta JA}$	120	$^\circ C/W$

➤ **Electrical Characteristics (T_J=25°C Unless otherwise noted)**

Parameter	Symbol	Conditions	Min.	Typ	Max.	Unit
Static						
Drain-Source Breakdown Voltage	$V_{(BR)DSS}$	$V_{GS}=0V, I_D=-250\mu A$	-60			V
Gate Threshold Voltage	$V_{GS(th)}$	$V_{DS}=V_{GS}, I_D=-250\mu A$	-1.0		-2.0	
Gate Leakage Current	I_{GSS}	$V_{DS}=0V, V_{GS}=\pm 12V$			± 100	nA
Zero Gate Voltage Drain Current	I_{DSS}	$V_{DS}=-48V, V_{GS}=0V$			-1	uA
		$V_{DS}=-48V, V_{GS}=0V$ $T_J=85^\circ C$			-30	
On-State Drain Current	$I_{D(on)}$	$V_{DS} \leq -5V, V_{GS}=-10V$	-5			A
Drain-Source On-Resistance	$R_{DS(on)}$	$V_{GS}=-10V, I_D=-4.8A$		125	135	mΩ
		$V_{GS}=-4.5V, I_D=-3.6A$		135	155	
Forward Transconductance	g_{FS}	$V_{DS}=-15V, I_D=-2.2A$		5		S
Diode Forward Voltage	V_{SD}	$I_S=-1.5A, V_{GS}=0V$		-0.75	-1.3	V
Dynamic						
Total Gate Charge	Q_g	$V_{DS}=-30V, V_{GS}=-4.5V$ $I_D=-2.2A$		5	10	nC
Gate-Source Charge	Q_{gs}			1.5		
Gate-Drain Charge	Q_{gd}			2.5		
Input Capacitance	C_{iss}	$V_{DS}=-30V, V_{GS}=0V$ $f=1MHz$		410		pF
Output Capacitance	C_{oss}			45		
Reverse Transfer Capacitance	C_{riss}			20		
Turn-On Time	$t_{d(on)}$	$V_{DD}=-30V, R_L=16.7\Omega$ $I_D=-1.8A, V_{GEN}=-10V$ $R_G=1\Omega$		5	10	ns
	t_r			15	25	
Turn-Off Time	$t_{d(off)}$			20	35	
	t_f			10	20	

➤ Typical Characteristics

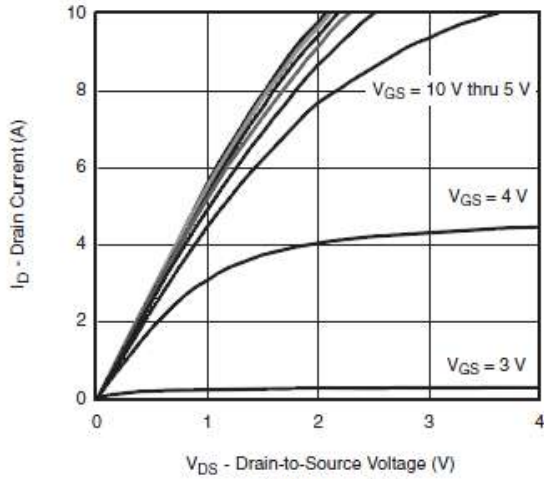

$V_{GS} = 10V$ thru $5V$
 $V_{GS} = 4V$
 $V_{GS} = 3V$

Output Characteristics

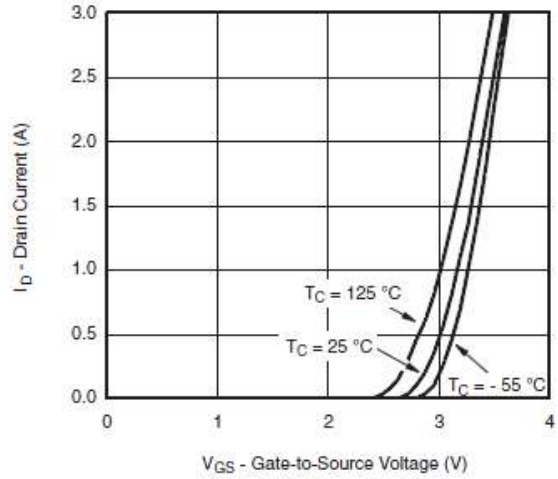

$T_C = 125^\circ C$
 $T_C = 25^\circ C$
 $T_C = -55^\circ C$

Transfer Characteristics

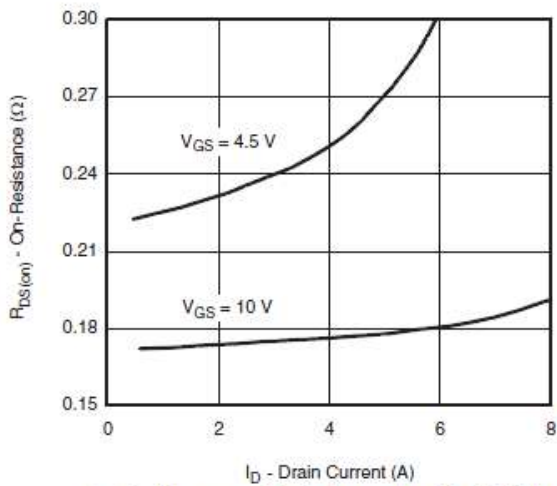

On-Resistance vs. Drain Current and Gate Voltage

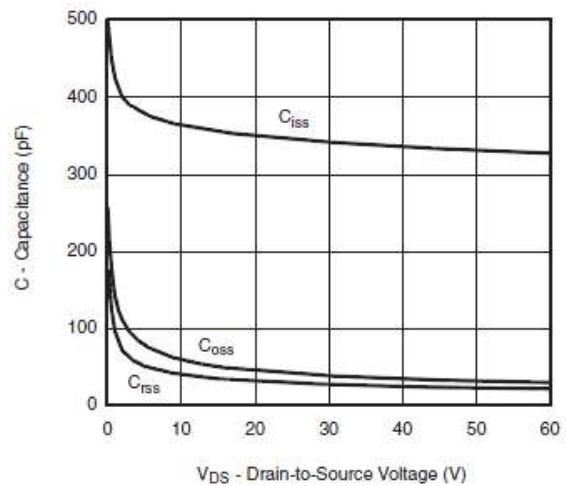

Capacitance

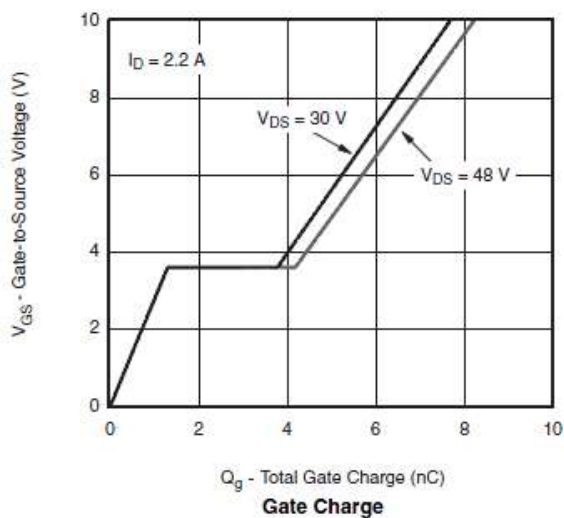

Gate Charge

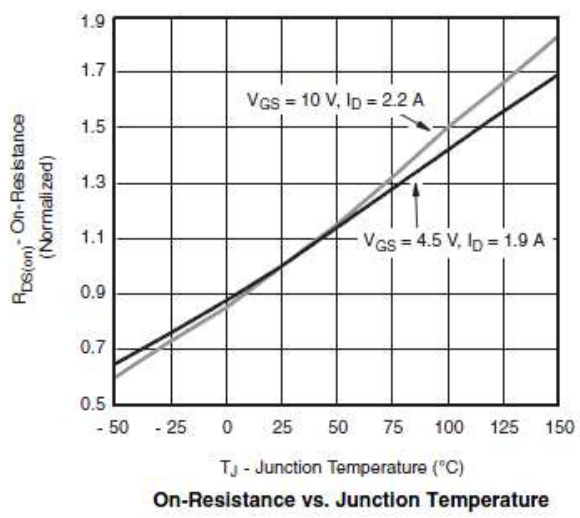

On-Resistance vs. Junction Temperature

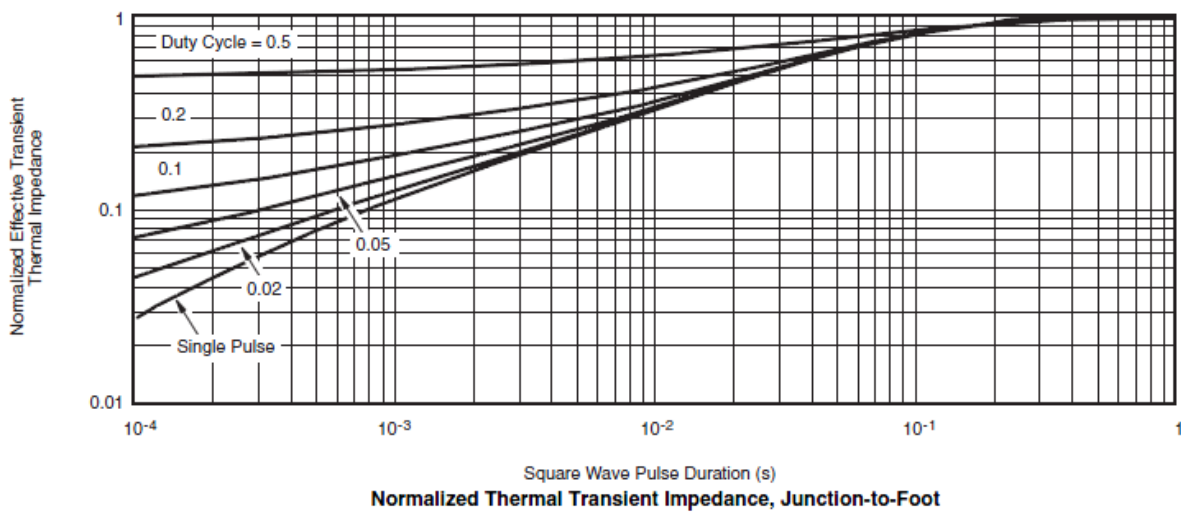
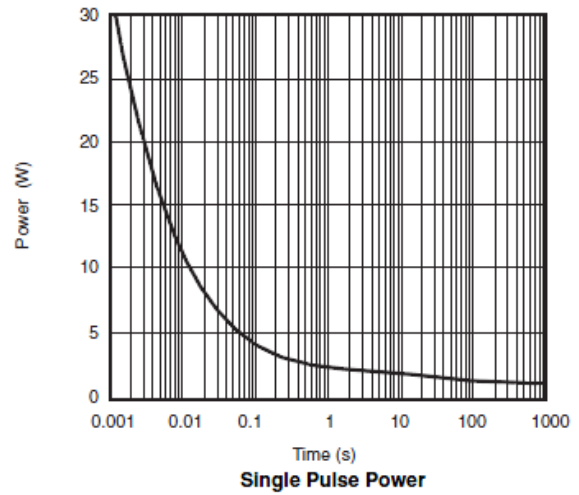
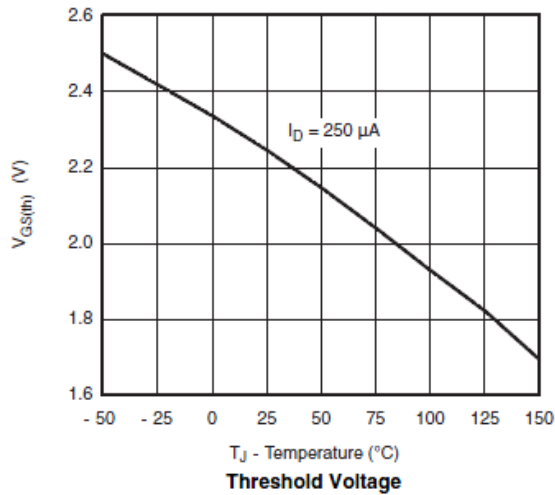
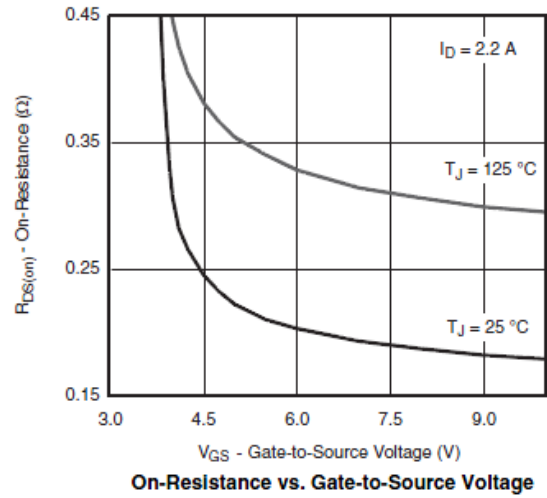
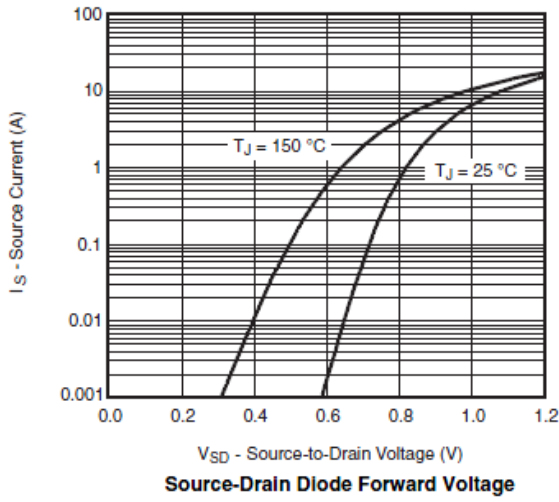

➤ Recommend IR Reflow Soldering Thermal Profile



Profile Feature	Pb-Free Assembly Profile
Temperature Min. (T _{smin})	150°C
Temperature Max. (T _{smax})	200°C
Time (t _s) from (T _{smin} to T _{smax})	60-120 seconds
Average Ramp-up Rate (t _L to t _P)	3°C/second max.
Liquidous Temperature (T _L)	217°C
Time (t _L) Maintained Above (T _L)	60 – 150 seconds
Peak Temperature	260°C +0°C / -5°C
Time (t _P) within 5°C of actual Peak Temperature	30 seconds
Ramp-down Rate (T _P to T _L)	6°C/second max
Time 25°C to Peak Temperature	8 minutes max.

➤ Ordering Information

Part Number	Description	Quantity
PAP84TB73QB	SOT-223 Reel	2500 pcs

➤ Package Information (SOT-223)

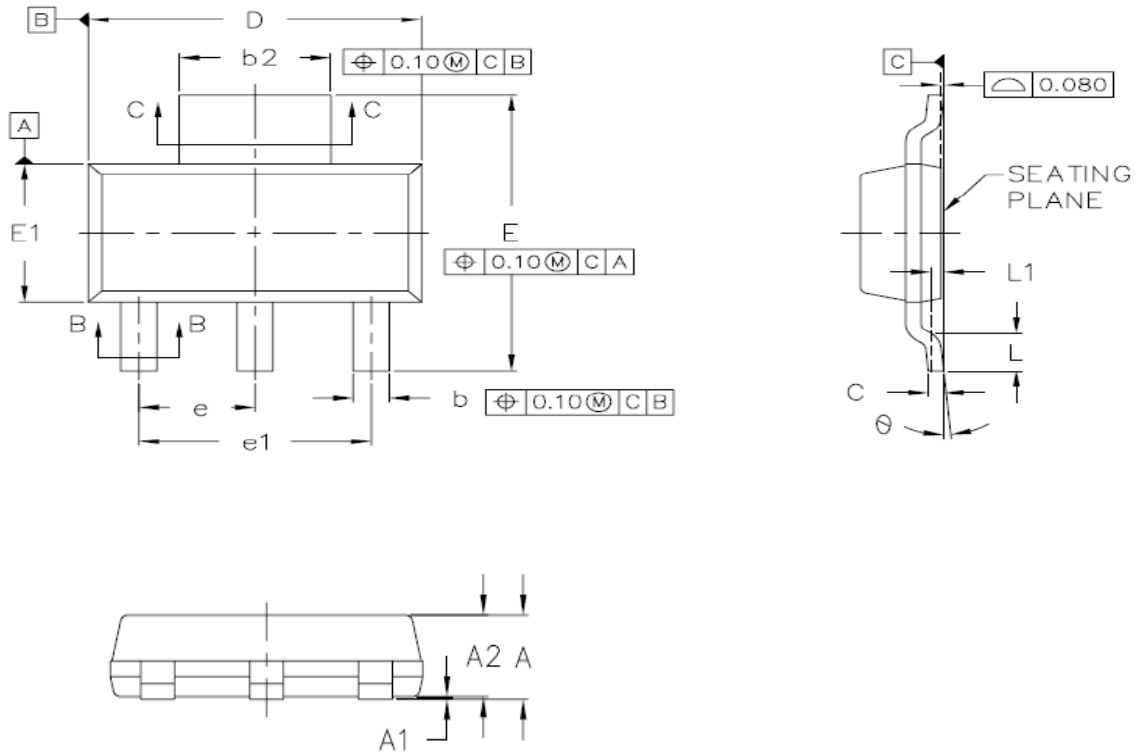

DIMENSIONS	COMMON			
	MM		INCH	
	MIN.	MAX.	MIN.	MAX.
A	—	1.80	—	0.071
A1	0.02	0.10	0.001	0.004
A2	1.50	1.70	0.059	0.067
b	0.66	0.84	0.026	0.033
b1	0.60	0.79	0.024	0.031
b2	2.90	3.10	0.114	0.122
b3	2.84	3.05	0.112	0.120
c	0.23	0.35	0.009	0.014
c1	0.23	0.33	0.009	0.013
D	6.30	6.70	0.248	0.264
E	6.70	7.30	0.264	0.287
E1	3.30	3.70	0.130	0.146
e	2.30 BSC.		0.091 BSC.	
e1	4.60 BSC.		0.182 BSC.	
L	0.81	—	0.032	—
L1	0.25 BSC.		0.010 BSC.	
θ	0°	10°	0°	10°

DISCLAIMER

- The information in this document and any product described herein are subject to change without notice and should not be construed as a commitment by Paceleader, Paceleader reserve the right to make changes to the information in this document.
- Though Paceleader make effort to improve product quality and reliability, Product can malfunction and fail due to their inherent electrical sensitivity and vulnerability to physical stress, it is the responsibility of the customer, when utilizing Paceleader products, to comply with the standards of safety in making a safe design for entire system and to avoid situation in which a malfunction or failure., In developing a new designs, customer should ensure that the device which shown in this documents are used within specified operatingranges.
- The information contained herein is presented only as a guide for the applications of our products. No responsibility is assumed by Paceleader for any infringements of patents or other rights of the third parties which may result from its use.